

Notes

- 1) Supporting steelwork and anchor bolts to be designed and furnished by others.
- 2) All supporting steel must be flush and level at top.
- 3) Beams should be selected in accordance with accepted structural practice.
- 4) Supporting steel will be greater than or equal to the length of the unit's base.
- 5) Unit may not be point supported. Support must extend the entirety of unit length.
- 6) Each beam should be designed, as a minimum, for 65% of the total unit operating weight applied as a uniformly distributed load.
- 7) Weights include all of the options and accessories.

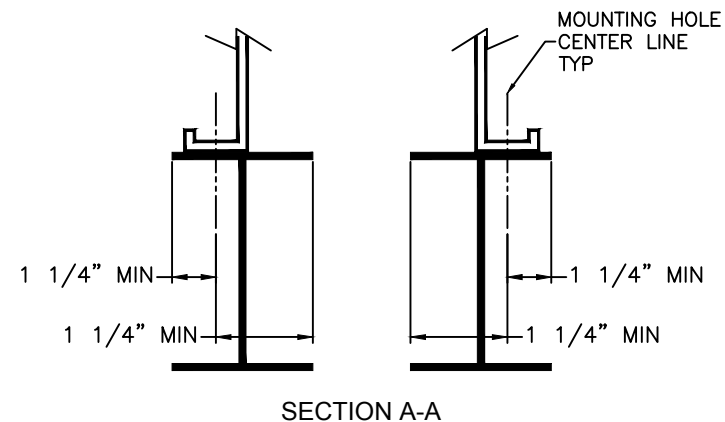

PLAN "A" STEEL

Model Number	Shipping/Rigging Weight	Operating Weight
TSDC2-CO2-509-31.0	9372	10494

ORDER NO:

DATE:



**BALTIMORE AIRCOIL COMPANY**

**TrilliumSeries™ Adiabatic Condenser Unit Support**

DRAWING NUMBER: