



**BALTIMORE
AIRCOIL COMPANY**

Universal Electric Water Level Control

INSTALLATION, OPERATION & MAINTENANCE MANUAL

FOR PART NUMBER 313555

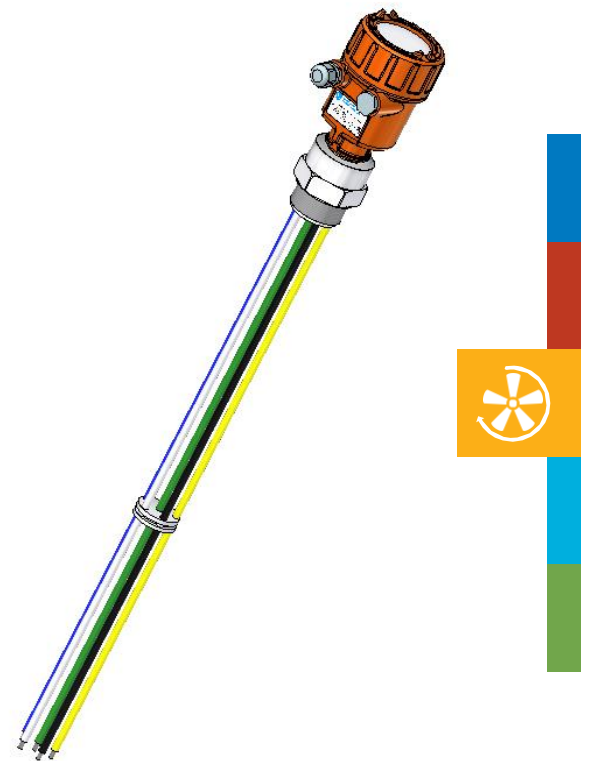



Universal Electric Water Level Control (313555)

INSTALLATION, OPERATION & MAINTENANCE MANUAL

Contents

1. Introduction	3
2. Installation.....	5
Installation	5
Wire Colors	8
Building Management System (BMS)	8
Wiring	8
2. Operation	10
Sequence of Operation	10
LED Error Indicator Lights	13
LED Indicator Lights	14
Operation and Maintenance	14
EWLC Specifications	14

1. Introduction

BAC-EWLC-6P (BAC Part Number 313555) is a 6-probe electronic water level controller (EWLC). This EWLC is a conductivity actuated, probe type liquid level controller that is used for:

- Maintaining proper operation water level when connected to a normally closed solenoid valve in evaporative heat rejection equipment
- Outputting alarm and shutdown signal for present water levels

This EWLC provides vital water level sensing and control functions as per BAC control parameters. It provides 4 status LEDs along with 3 error LEDs to provide clear indications of operational status and level related errors, along with quality of water for proper operation of entire system. See **Figure 1** & **Figure 2** for an overview of the main EWLC components.

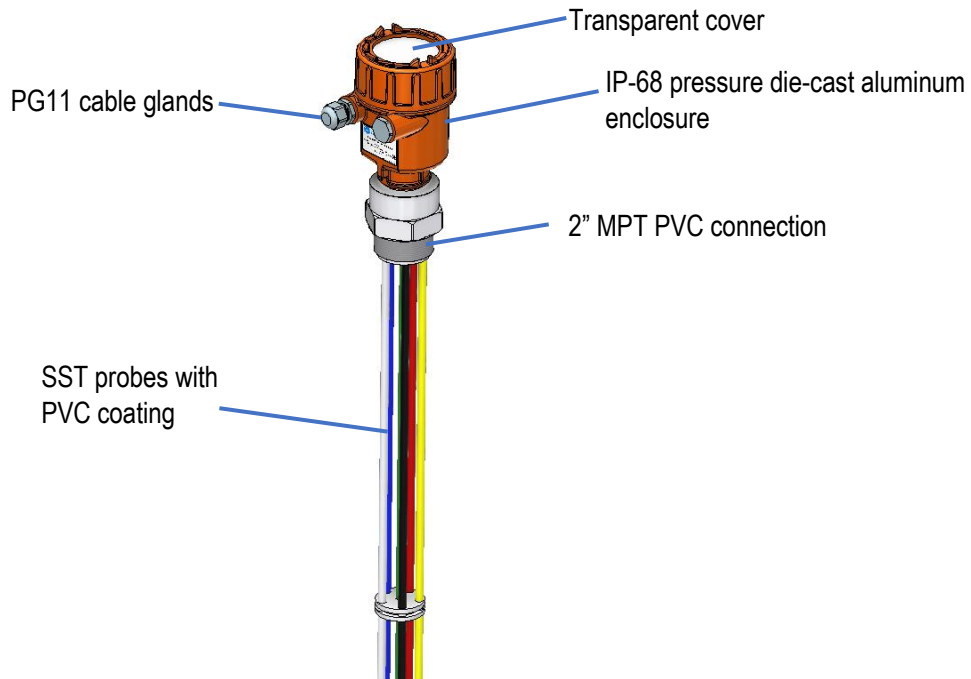

Figure 1. EWLC Overview



NOTE: For the previous version EWLC please refer to the [Installation, Operation & Maintenance Manual on BaltimoreAircoil.com](#)

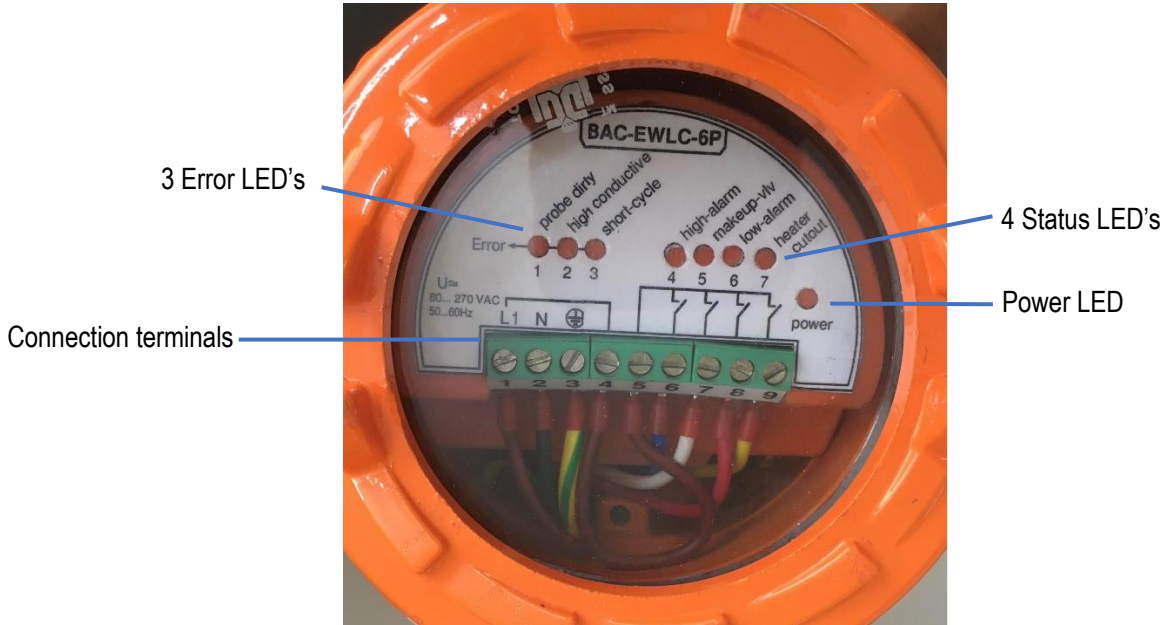

Figure 2. Top View of EWLC

2. Installation

Installation

On new equipment the EWLC will ship installed with a 6' long UV resistant wiring cable factory installed. For retrofit assemblies purchased through BAC Aftermarket follow the below procedure.

1. Verify the parts listed in **Table 1** are included. Note parts are provided for universal installation. Not all parts will be required for installation. Power wiring, disconnects, fusing, and auxiliary control wiring are by others and must comply with all applicable codes and ordinances

Quantity	Description
1	Stilling Chamber, 2" PVC Pipe
1	2" S x F PVC Coupling
2	Universal Mounting Bolts
2	2" U-Bolt
4	Plastic Wing Nut
1	Tank Fitting for Wiring Cable
8	Self Tapper, 5/16" x 3/4"
8	Seal Washer, 5/16"
8	Bolt 5/16" x 1"
8	Nut, 5/16" – UNC
8	Flat Washer, 5/16"
8	Lock Washer, 5/16"
1	Roll Sealer Tape

Table 1. Parts List

2. Select a suitable mounting location in the tower. Mount near a door or access way for easy adjustment or cleaning.
3. Use mounting brackets and hardware as needed for installation.
4. Attach the stilling chamber, 2" S x F PVC Coupling, and probe assembly to the mounting bracket with 2 U-bolts and plastic wing nuts (see **Figure 3**). **Do not glue** any of these parts together. They are designed to be taken apart for easy, routine maintenance.
5. Cut probes to correct lengths and set operating level. Probes can be cut with a hack saw or cut-off wheel that is designed for cutting stainless steel. The water level set point (valve open) is 4" above the bottom of the stilling chamber. Check the unit Operation and Maintenance Manual for the proper operating level. Remove probe sheath 1" on each probe end to expose bare metal.
6. Drill a 7/8" hole in the tower casing to pass the wiring cable to the outside of the unit. Attach the watertight, "through the-wall", tank fitting. Leave adequate slack in the wiring inside the tower to allow the control assembly to be removed from the stilling chamber for cleaning.
7. Wire the control per the diagram on **Page 9**.

8. A normally closed (NC), 120 VAC slow closing, solenoid valve is required on the make-up line. Refer to the **Table 2** for suggested valve sizing. These valves are available as an accessory from your [local BAC Representative](#). The valve size is the minimum recommended size for a single cell cooling tower of the rated tonnage. Multiple cell cooling towers may require a larger size valve or multiple valves piped in parallel due to greater basin volumes.

Tower Size Nominal Tons	Valve Size NPT	BAC Part Number
0-150	1/2"	310782
150-250	3/4"	310783
250-650	1"	310784
650-1301	1 1/2"	310785

Table 2. Make-up Solenoid Valve Selection

9. Hand fill the cooling tower until the water level is 1/2" below the overflow connection.
10. Energize the system.
11. Check the tower periodically during the first few hours of operation to ensure the control is working properly and the water level is set properly.
12. The water level may be adjusted by simply loosening the U-bolts and repositioning the control assembly.

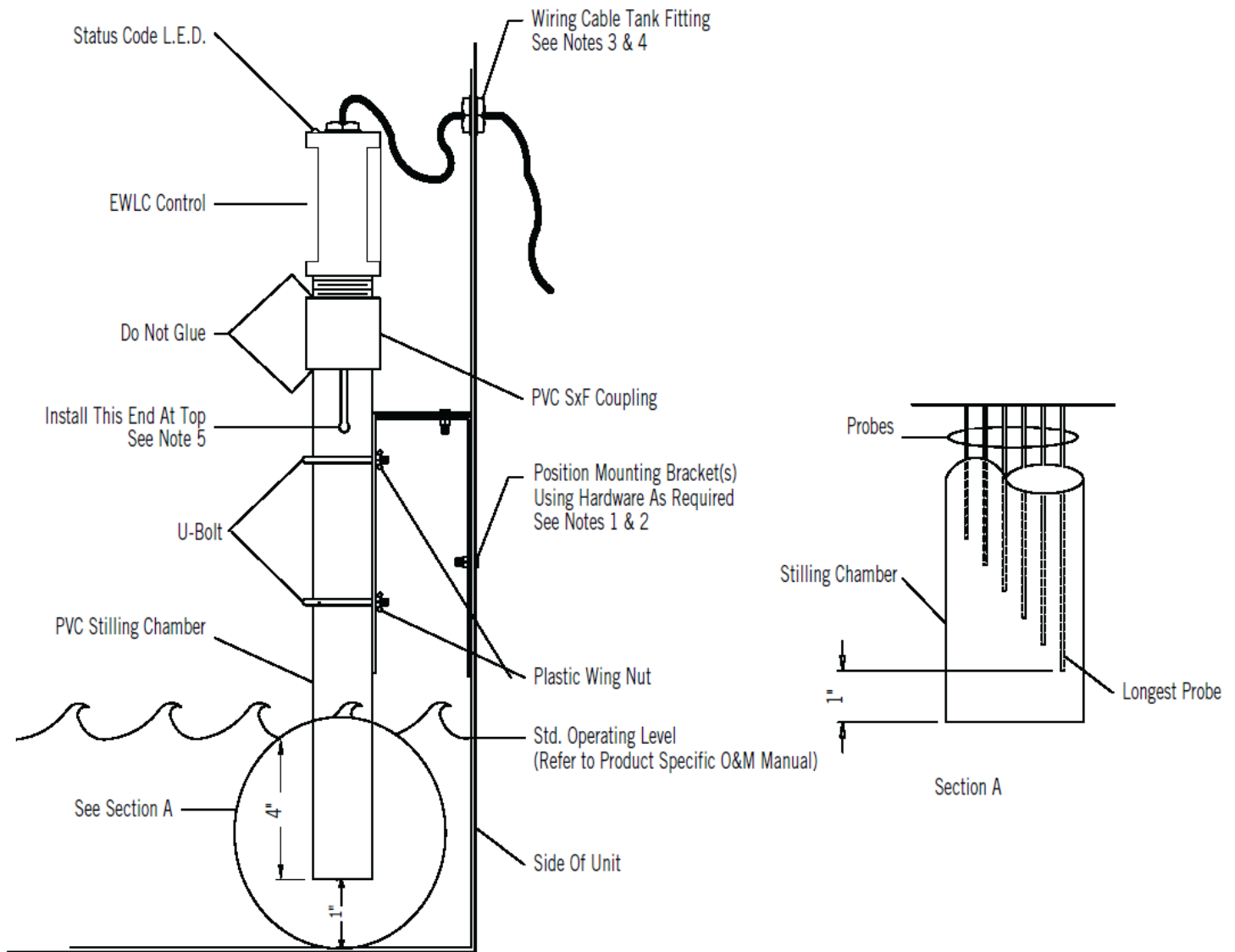

Figure 3. Typical Installation

Notes:

1. Drill 1/4" hole for tappers.
2. Drill 11/32" pilot for bolts.
3. Drill 7/8" hole for cable tank fitting.
4. Leave adequate slack in wiring cable to allow the control head to be lifted from the stilling chamber for inspection and cleaning.
5. Do not cut this end. The purpose of the slot at this end is to vent air.

Wire Colors

Wire Color	Description
Brown	Power supply hot
Black	Power supply neutral
Green/Yellow	Ground
Blue	High alarm
White	Makeup valve
Red	Low alarm
Yellow	Heater cutout

Table 3. Wire Color & Description

Building Management System (BMS)

A control relay is required if EWLC outputs are used as input to a building management system. EWLC output voltage is dependent on input voltage as illustrated in **Figure 4**.

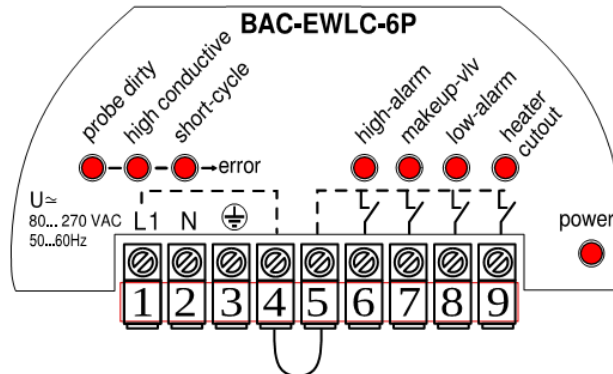
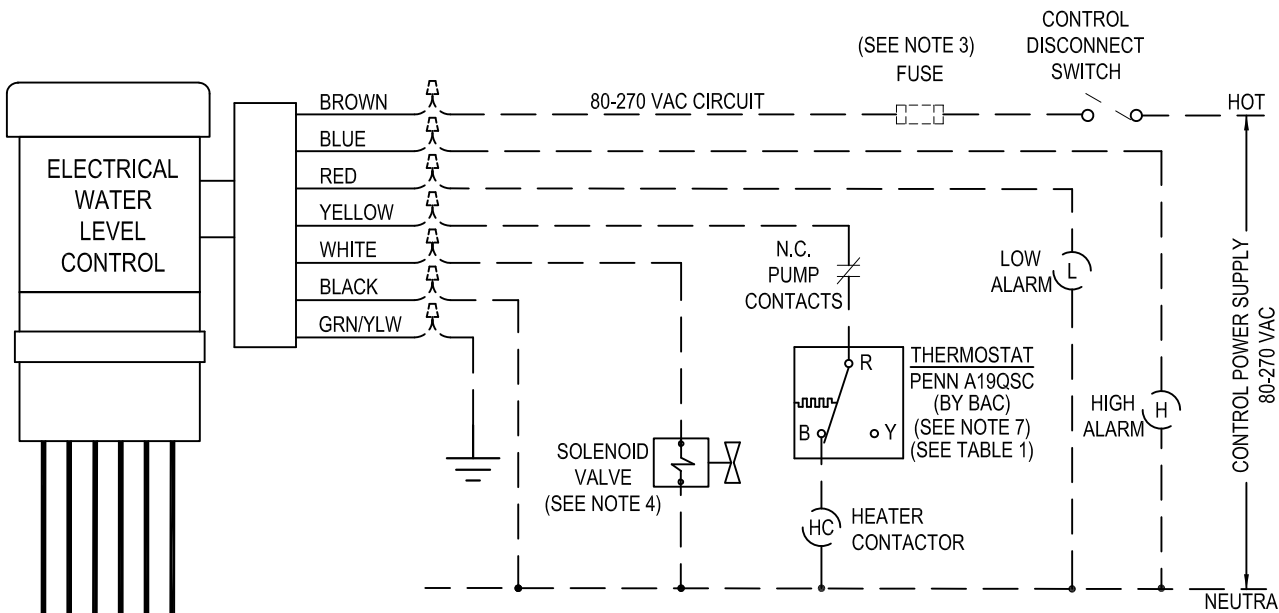

Figure 4. EWLC Wiring Diagram

Wiring

The EWLC will ship installed with a 6' long UV resistant wiring cable. Refer to the unit submittal package for the correct EWLC wiring diagram. Diagram provided on **Page 9** is superseded by any drawing supplied in the unit submittal package. Put watertight wire nut(s) on end of wires that are not used.



NOTES:

1. WIRING AND COMPONENTS INDICATED BY DASHED LINES ARE TO BE SUPPLIED BY FIRMS OTHER THAN BAC. ALL WIRING MUST COMPLY WITH APPLICABLE CODES AND ORDINANCES.
2. THE WATER LEVEL CONTROL BOARD IS WIRED IN THE INVERSE MODE SO THAT THE SOLENOID MAKE-UP VALVE WILL CLOSE IF THERE IS A LOSS OF POWER TO THE CONTROL BOARD. WHEN THE WATER LEVEL RISES TO THE BOTTOM OF THE MAKE-UP VALVE OFF PROBE AND MAINTAINS CONTACT FOR AT LEAST 6 SECONDS, THE CONTROL DE-ENERGIZES THE VALVE. THE VALVE REMAINS DE-ENERGIZED UNTIL THE WATER LEVEL RECEDES BELOW THE BOTTOM OF THE MAKE-UP VALVE ON PROBE AND REMAINS AT THAT LEVEL FOR AT LEAST 6 SECONDS. THE CONTROL THEN ENERGIZES THE VALVE.
3. ANY INCOMING POWER SOURCE MUST HAVE A 3A FUSE FOR COMPONENT PROTECTION. USING A FUSE OVER 3A WILL VOID BAC WARRANTY.
4. THE SOLENOID ACTUATED MAKE-UP VALVE IS RATED AT 6.1 WATTS, 16 VA HOLDING, 30 VA INRUSH.
5. THE NORMALLY CLOSED SOLENOID VALVE HAS A SLOW CLOSING FEATURE WHICH MINIMIZES WATER HAMMER AND IS DESIGNED TO OPERATE AT MAKE-UP WATER LINE PRESSURES OF 10 TO 125 PSIG. TO FURTHER MINIMIZE THE POTENTIAL FOR WATER HAMMER, MAKE-UP WATER LINE PRESSURES AT THE HIGHER END OF THE RANGE SHOULD BE AVOIDED, AND MAKE-UP PIPING SHOULD BE WELL SUPPORTED.
6. INTERLOCK IMMERSION HEATERS WITH CIRCULATING PUMP TO DE-ENERGIZE HEATERS WHEN PUMP IS RUNNING.
7. CONTROL THERMOSTAT IS TO BE SET FOR 40°F. DO NOT SET THERMOSTAT LOWER THAN 40°F.
8. A STRAINER IS REQUIRED BEFORE THE SOLENOID MAKE-UP VALVE.
9. WHEN A LIGHTING ON L.E.D. INDICATOR MEANS THE FUNCTION IS ACTIVE OR ERROR FOUND.

- HIGH ALARM (BLUE)
- MAKE UP VALVE OFF (BLACK)
- MAKE UP VALVE ON (WHITE)
- LOW ALARM (RED)
- HEATER CUTOUT (YELLOW)
- GROUND (GREEN)

CAUTION
ONLY AUTHORIZED PEOPLE
CAN OPEN THE TOP COVER!

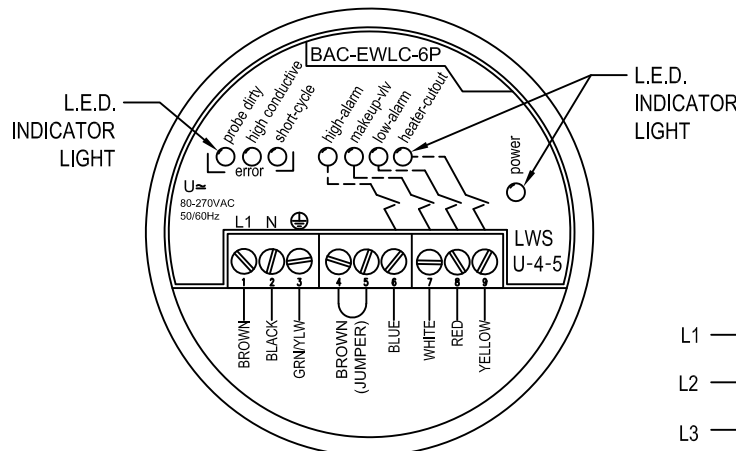
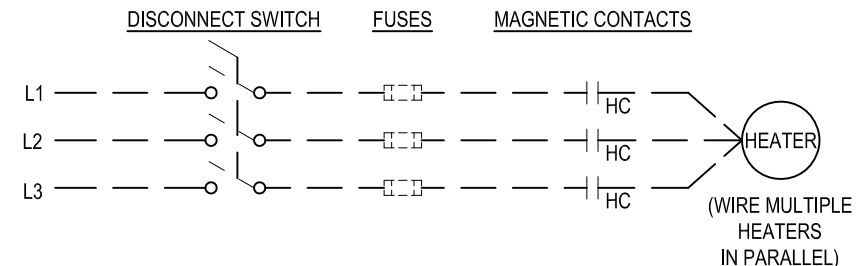

TABLE 1

ELECTRICAL RATINGS FOR PENN A19QSC THERMOSTAT	
VOLTAGE, AC ONLY	120
FULL LOAD AMPS	16.0
LOCKED ROTOR AMPS	96.0
WHEN CONNECTED	22.0
NON-IND. SPST	
AMPS WHEN CONNECTED	16.0
SPDT	
PILOT DUTY	125 VA, 24/600 VAC

EWLC PANEL
 OPEN TOP COVER TO CHECK
 LED INDICATOR STATUS
 (SEE NOTE 9)

RECOMMENDED WIRING OF OPTIONAL HEATER PACKAGE



ORDER NO:

DATE:



BALTIMORE AIRCOIL COMPANY

EWLC Wiring
Heater Cutout, High & Low Alarm





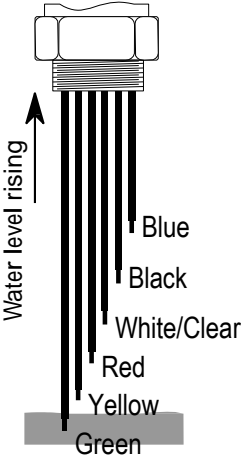
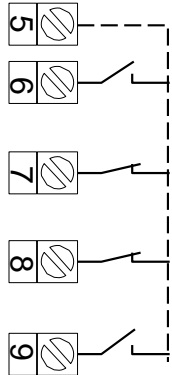
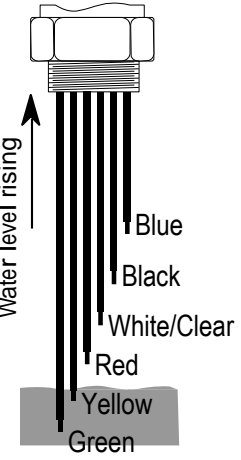
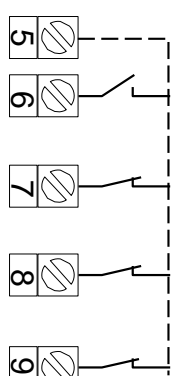
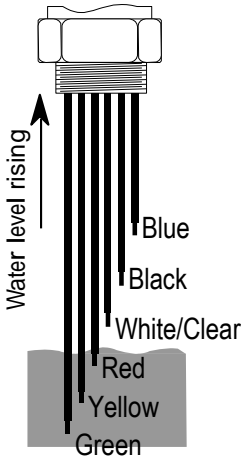
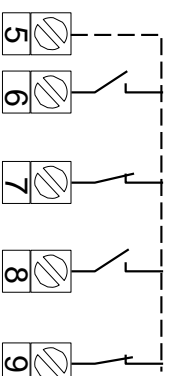

DRAWING NUMBER:

2. Operation

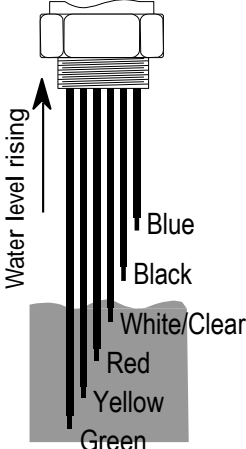
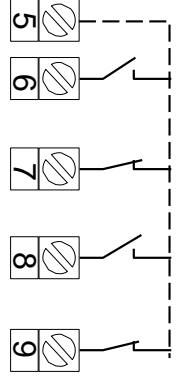
Sequence of Operation

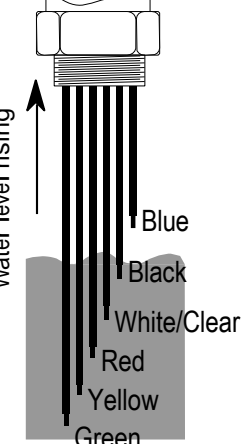
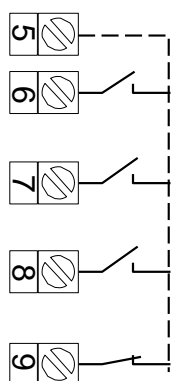
The following information explains EWLC operation with respect to water level.

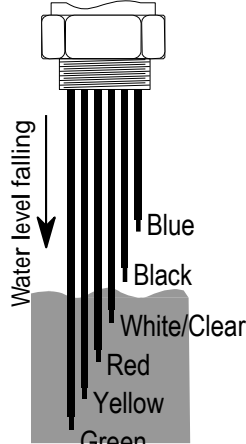
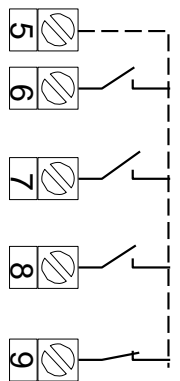



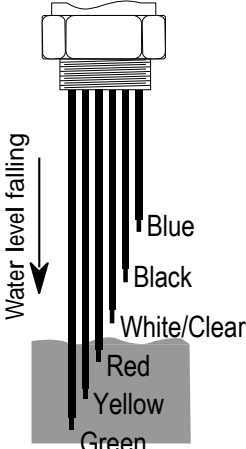
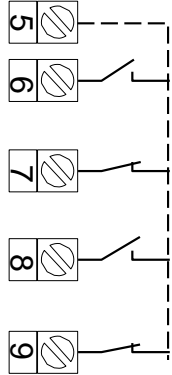
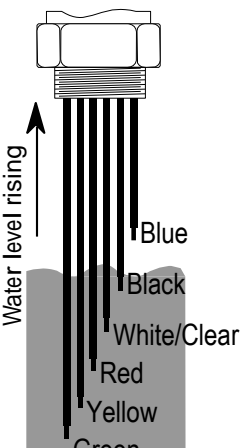
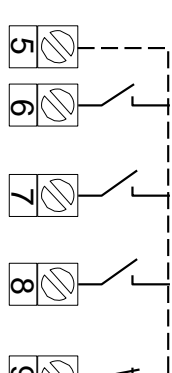
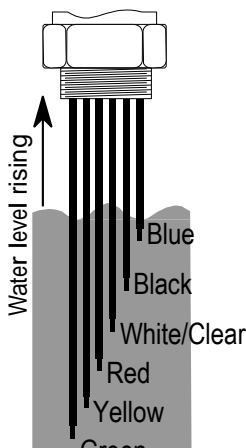
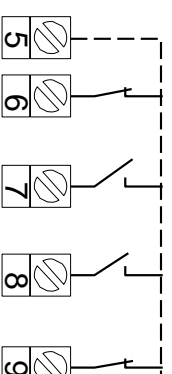

Water Level at Probe	Terminals	LED	LED / Alarm Name	Explanation
		<ul style="list-style-type: none"> ● ☀ ☀ ☀ 	<ul style="list-style-type: none"> High Alarm OFF Makeup-Valve ON Low Alarm ON Heater Cutout ON 	<p>When water level is lower than yellow probe. Heater is cutout due to low level of water.</p>
		<ul style="list-style-type: none"> ● ☀ ☀ ● 	<ul style="list-style-type: none"> High Alarm OFF Makeup-Valve ON Low Alarm ON Heater Cutout OFF 	<p>When water fills up to yellow probe, terminal 9 shorts from terminal 5.</p> <p>Heater can now be turned ON as water level is sufficient for the heater to operate.</p>
		<ul style="list-style-type: none"> ● ☀ ● ● 	<ul style="list-style-type: none"> High Alarm OFF Makeup-Valve ON Low Alarm OFF Heater Cutout OFF 	<p>When water fills up to red probe, terminal 8 open from terminal 5.</p>

Water Level at Probe	Terminals	LED	LED / Alarm Name	Explanation
		<ul style="list-style-type: none"> ●  	<ul style="list-style-type: none"> ● High Alarm OFF ● Makeup-Valve ON ● Low Alarm OFF ● Heater Cutout OFF 	<p>When water fills up to white/clear probe, no change is made as this level is lower level for make-up valve ON/OFF operation.</p>
		<ul style="list-style-type: none"> ●  	<ul style="list-style-type: none"> ● High Alarm OFF ● Makeup-Valve OFF ● Low Alarm OFF ● Heater Cutout OFF 	<p>When water fills up to black probe, terminal 7 opens from terminal 5.</p>
		<ul style="list-style-type: none"> ●  	<ul style="list-style-type: none"> ● High Alarm OFF ● Makeup-Valve OFF ● Low Alarm OFF ● Heater Cutout OFF 	<p>If water falls lower than black probe, but not below white/clear probe, terminal 7 stays open from terminal 5.</p>

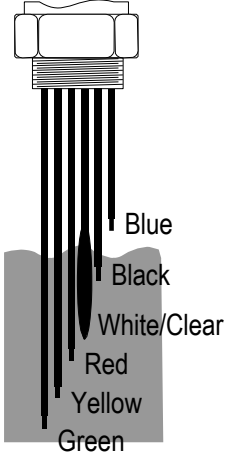
Water Level at Probe	Terminals	LED	LED / Alarm Name	Explanation
 <p>Water level falling</p> <p>Blue Black White/Clear Red Yellow Green</p>		<ul style="list-style-type: none"> ● ☀ ● ● 	<ul style="list-style-type: none"> High Alarm OFF Makeup-Valve ON Low Alarm OFF Heater Cutout OFF 	<p>If water level falls lower than white/clear probe, terminal 7 shorts to terminal 5 to turn make-up valve ON.</p>
 <p>Water level rising</p> <p>Blue Black White/Clear Red Yellow Green</p>		<ul style="list-style-type: none"> ● ● ● ● 	<ul style="list-style-type: none"> High Alarm OFF Makeup-Valve OFF Low Alarm OFF Heater Cutout OFF 	<p>When water fills up to black probe, terminal 7 opens from terminal 5, turning make-up valve OFF.</p>
 <p>Water level rising</p> <p>Blue Black White/Clear Red Yellow Green</p>		<ul style="list-style-type: none"> ☀ ● ● ● 	<ul style="list-style-type: none"> High Alarm ON Makeup-Valve OFF Low Alarm OFF Heater Cutout OFF 	<p>When water fills up to blue probe, terminal 6 shorts to terminal 5, to give high alarm.</p>

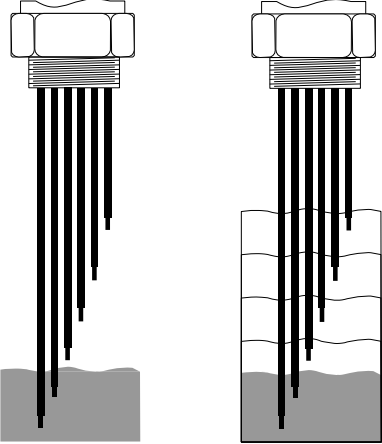
LED Error Indicator Lights

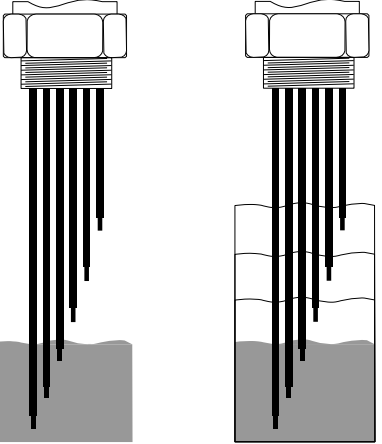
There are three error indicating LEDs for the following conditions of water quality and level.

Probe Condition	Description	LED
	<p>Water level is sensed at black probe but not at white/clear probe. White/clear probe should be dipped when level is up to black probe.</p>	<p> short-cycle</p> <p>Short-cycle LED will stay OFF other wise</p>
	<p>Sensing probe dipped in high conductivity water, indicating presence of minerals that may lead to rusting</p>	<p> High conductive</p> <p>High conductive LED will stay OFF other wise</p>
	<p>At least two level probes dipped in water having low conductivity, indicating presence of organic growth around probes or dirty probes.</p>	<p> Probe dirty</p> <p>Probe dirty LED will stay OFF other wise</p>

LED Indicator Lights

Light Mark	Function if light on
Power	Power supplied
Probe Dirty	Notify probe needs to be cleaned
High Conductive	Water conductivity is too high, notify high saline water
Short-Cycle	Short circuit between probes
High-Alarm	Water level is too high
Makeup-Valv	Makeup valve is on
Low-Alarm	Water level is too low
Heater-Cutout	Water level is higher than heater

Table 4. LED Indicator Light Function

Operation and Maintenance

The control/probe head is fully potted and sealed so there are no user serviceable electronic components. The only services that are required are:

1. Clean the stainless-steel electrodes periodically to prevent accumulations of scale, corrosion, sludge or biological growth, which could interfere with the electrical circuit.
2. The water level is maintained at the recommended operating level regardless of the system thermal load. Therefore, it is not recommended that the operating level be adjusted.
3. During the start-up of units equipped with the electric water level control package, by-pass the control unit in order to fill the unit to the overflow connection.

EWLC Specifications

BAC part number	313555
Input power	80 – 270VAC, 50/60Hz
Enclosure type	IP68
Operational ambient temperature range	-20°F - 104°F
Time Delay	6 seconds

Table 5. EWLC Specifications



NOTE: Recommended valve type is a slow closing 120 VAC, normally closed solenoid valve, designed to reduce water hammer.

Universal Electric Water Level Control

INSTALLATION, OPERATION & MAINTENANCE MANUAL
FOR PART NUMBER 313555



baltimoreaircoil.com