

Notes

- 1) All dimensions are in feet and inches. Weights are in pounds and include options and accessories.
- 2) Unless otherwise indicated, connections 3" and smaller are MPT. Connections 4" and larger are grooved to suit a mechanical coupling and beveled for welding.
- 3) Field piping should be fabricated at time of installation. Pre-fabrication of pipe work is not recommended.
- 4) Do not support piping from unit connections. All necessary piping supports to be supplied by others.
- 5) For weight loadings and support requirements, refer to the suggested unit support drawing.
- 6) The area above the fan discharge must be unobstructed.
- 7) Due to height limitations on truck shipments, some items shown may ship loose for field installation.
- 8) Weights and dimensions are for base structure units with no accessories or optional features, values may vary depending upon unit configuration.
- 9) Connection sizes and locations are selected for pump suction applications at the designed flow rates. Sizes and locations may vary depending upon configuration options and design conditions.
- 10) Inlet is Studded Bolt Circle for mating to a 150# class ASME Flange.

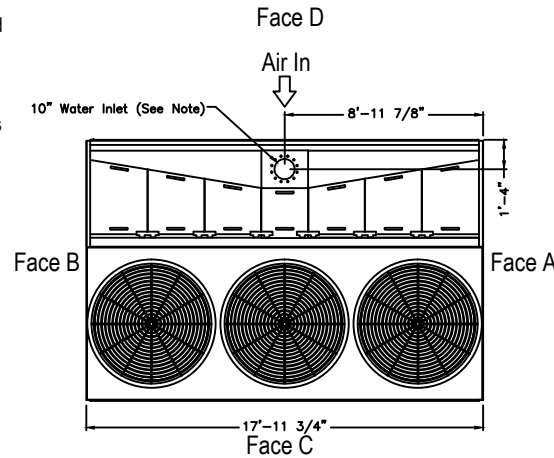

Model Number	Operating Weight	Shipping Weight	Heaviest Section Weight
XES15E-1218-11EN	28970	12830	6640
XES15E-1218-11FN	29030	12890	6700
XES15E-1218-11GN	29120	12980	6790
XES15E-1218-11HN	29150	13010	6820
XES15E-1218-11JN	29300	13160	6970
S15E-1218-11KN	29340	13200	7010
S15E-1218-11LC	29720	13580	7390
S15E-1218-11LN	29720	13580	7390
S15E-1218-11MN	29900	13760	7570

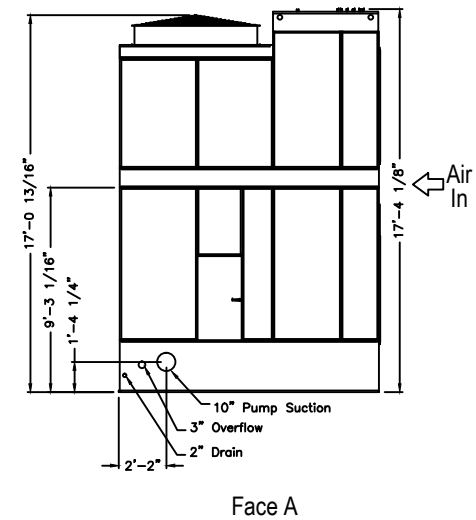
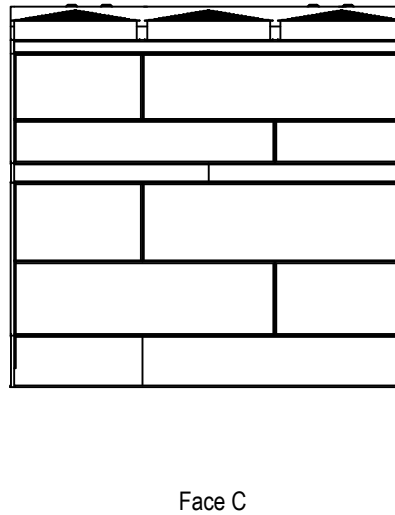
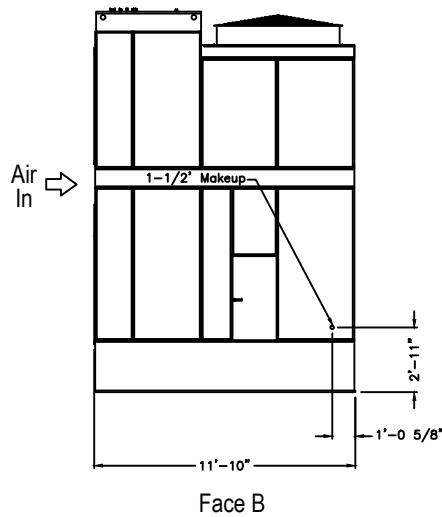

ORDER NO:

DATE: **3/18/2014**



BALTIMORE AIRCOIL COMPANY

**Series 1500 Single Cell Unit Print
1218-11**

DRAWING NUMBER:
UP-XE-S15E-1218-11